

ZL-1903 *Zwei L* Stainless Steel Knob

Features

- Superior "Zwei L Finish" - *Zwei L* represents the very pinnacle of ultra-premium Japanese hardware design. The contrasting bands of mirror finish and lustrous satin on a faceted profile give a jewel like finish that highlights and enhances any industrial design

Parts Included

- M4x25 truss head screw (SUS)

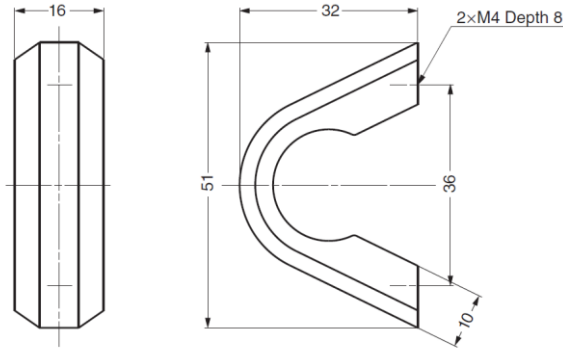

Part No.	Material	Finish
ZL-1903	Stainless Steel 316	Zwei L Finish

ZL-1904 *Zwei L* Stainless Steel Knob

Features

- Superior "Zwei L Finish" - *Zwei L* represents the very pinnacle of ultra-premium Japanese hardware design. The contrasting bands of mirror finish and lustrous satin on a faceted profile give a jewel like finish that highlights and enhances any industrial design

Parts Included

- M4x25 truss head screw (SUS)

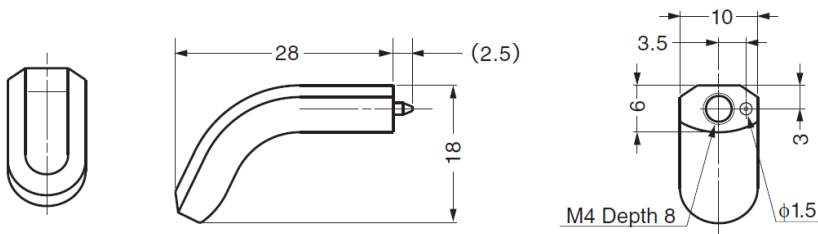

Part No.	Material	Finish
ZL-1904	Stainless Steel 316	Zwei L Finish